



FIORO

TECHNICAL ANNEX

Hochschrank Standard larder pull-out



Hochschrank Standard larder pull-out: The handy front pull-out for practical kitchens



Full-extension runner Compact Hochschrank Standard

For tubular frames Hochschrank Standard

- Includes Softopen and Softclose
- Includes automatic synchronisation
- Includes ClickFixx / quick assembly

Load capacity: 120 kg

	Surface	Width	Depth	Height	Art. No.
	anthracite	120	490	55	100.0874.43



Standard-extension runner Single Hochschrank Standard

For tubular frames Hochschrank Standard

- Includes Softopen and Softclose
- Includes ClickFixx / quick assembly

Load capacity: 100 kg

	Surface	Width	Depth	Height	Art. No.
	anthracite	79	495	55	100.0922.43



Height-adjustable tubular frame Hochschrank Standard

For full-extension runner Compact and standard-extension runner Single Hochschrank Standard

- Includes ClickFixx / quick assembly

Interior height = Height of tubular frame + Height of extension runner

Interior height	Surface	Width	Depth	Height	Art. No.
900 - 1300	anthracite		495	845-1245	100.0590.43
1200 - 1600	anthracite		495	1145-1545	100.0592.43
1600 - 2000	anthracite		495	1545-1945	100.0594.43
1805 - 2260	anthracite		495	1750-2205	100.0596.43



Fixed tubular frame Hochschrank Standard

For full-extension runner Compact and single-extension runner Single Hochschrank Standard

- Includes ClickFixx / quick assembly

Interior height = Height of tubular frame + Height of extension runner

Interior height	Surface	Width	Depth	Height	Art. No.
1999	anthracite		495	1944	100.0598.43

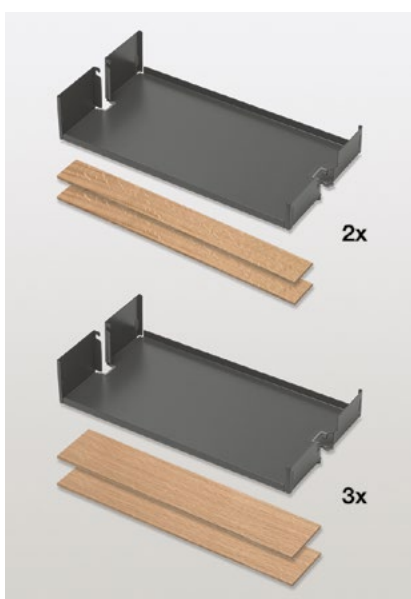

Clip-on shelf set Fiore 300/400

To clip onto the tubular frame Hochschrank Standard

Set includes:

5 clip-on shelves Fiore

6 wooden rails oak high (height 87 mm)

4 wooden rails oak medium (height 52 mm)

Unit width	Surface	Width	Depth	Height	Art. No.
300	anthracite	250	470	92	100.0942.43
400	anthracite	350	470	92	100.0943.43

Other widths available on request

Clip-on shelf set Fiore 150

Set includes:

15 clip-on shelves Fiore

18 wooden rails oak high (height 87 mm)

12 wooden rails oak medium (height 52 mm)

Compatible only with the standard-extension runner Single (100.0922.43)

Unit width	Surface	Width	Depth	Height	Art. No.
150	anthracite	100	470	92	100.0938.43

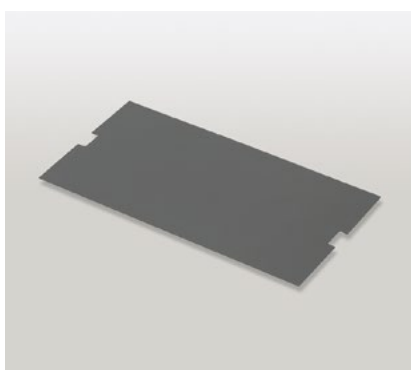

Non-slip mat Standard

For the Fiore and Libell clip-on shelf for Hochschrank Standard

- Gummed on both sides
- Raised diamond pattern
- Easy to remove for cleaning

Unit width	Surface	Width	Depth	Height	Art. No.
150	grey	65	440	1	100.0910.18
300	grey	215	440	1	100.0726.18
400	grey	315	440	1	100.0728.18

Other widths available on request



Shelf divider

Magnetic divider for Fiore and Libell shelves

- Can be attached to the shelf (base or side) or the non-slip mat

	Surface	Width	Depth	Height	Art. No.
	anthracite	85	26 / 3	90	100.0706.43

Order quantity: 4 pieces or a multiple per article number



E-Touch

Electronic door opener for full-extension runner Compact Hochschrank Standard

- For handle-free fronts – opens with a light tap
- Can be retrofitted

Impact force: max. 120 kg

Unit width: min. 300 mm

Requires: Softclose

Electromotive support: opening

Unit width	Surface	Width	Depth	Height	Art. No.
300	grey	68	333	77	100.0873.02



Front bracket

For the tubular frame Hochschrank Standard

- With ClickFixx connection and 3-dimensional adjustment

Two-part set

Unit width	Surface	Width	Depth	Height	Art. No.
150	anthracite	100			100.0892.43



Front bracket

For the tubular frame Hochschrank Standard

- With ClickFixx connection and 3-dimensional adjustment

Two-part set

Unit width	Surface	Width	Depth	Height	Art. No.
300	anthracite	250			100.0585.43
400	anthracite	350			100.0586.43

Hochschrank Pleno larder pull-out



Hochschrank Pleno larder pull-out: Just open the unit doors to make the unit's contents glide out smoothly



Hochschrank Pleno Fiore larder pull-out 1900

Complete mechanism set, including a set of Fiore clip-on shelves

Set includes:

- 1 main frame
- 1 frame top 1900
- 6 clip-on shelves Fiore
- 6 wooden rails oak medium (height 52 mm)
- 1 set of door connections
- 1 lower slide, including Softopen
- 1 upper slide

Opening angle: 110°
 Load capacity: 100 kg
 Interior depth: min. 500

Unit width	Surface	Width	Depth	Height	Art. No.
450	anthracite	412/418	495	1715	100.0956.43
600	anthracite	562/568	495	1715	100.0959.43

Other heights available on request

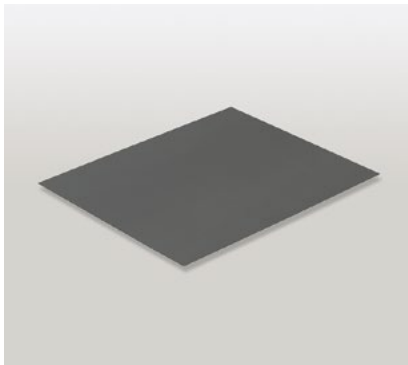

Non-slip mat Standard Fiore

For the Fiore clip-on shelf for Hochschrank Pleno

- Gummed surface
- Raised diamond pattern
- Easy to remove for cleaning

Unit width	Surface	Width	Depth	Height	Art. No.
450	grey	323	393	1	100.0964.18
600	grey	473	393	1	100.0965.18



Wooden box set “low” Pleno

For clip-on shelf Libell and Fiore for Hochschrank Pleno

Set includes:

1 x horizontal bracket (473 / 323 x 102 x 87 mm)

2 x small, low-sided boxes (247 x 148 x 50 mm)

Unit width	Surface	Width	Depth	Height	Art. No.
450	Light oak			50 / 87	100.0909.36
600	Light oak			50 / 87	100.0907.36

If the wooden box set is placed on the clip-on shelf Fiore as shown in the picture, then the wooden rail of the shelf must be removed. The wooden rail can be used, if the wooden box set is placed with a rotation of 90 degrees.

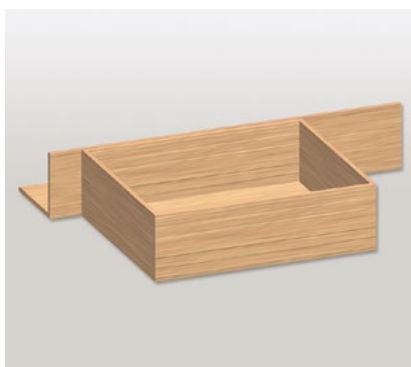

Wooden box set “high” Pleno

For clip-on shelf Libell and Fiore for Hochschrank Pleno

Set includes:

1 x horizontal bracket (473 x 102 x 87 mm)

1 x large, high-sided box (247 x 296 x 87 mm)

Unit width	Surface	Width	Depth	Height	Art. No.
600	Light oak			87	100.0908.36



Extra shelf set

For clip-on shelf Fiore and Libell for Hochschrank Pleno

- Magnetic - the magnetic feet stick to the shelf
- Shelf can be placed in three different positions
- An extra level of storage for pot lids and similar

Unit width	Surface	Width	Depth	Height	Art. No.
450	anthracite	309	226	160/164	200.1442.43
600	anthracite	459	226	160/164	200.1448.43



Shelf divider

Magnetic divider for Libell and Fiore shelves

- Can be attached to the shelf (base or side) or the non-slip mat

	Surface	Width	Depth	Height	Art. No.
	anthracite	85	26 / 3	90	100.0706.43

Order quantity: 4 pieces or a multiple per article number

Extendo pull-out shelf



Extendo pull-out shelf: The flexible pull-out shelf that is right at home anywhere

EXTENDO FIORO WITHOUT SPACER

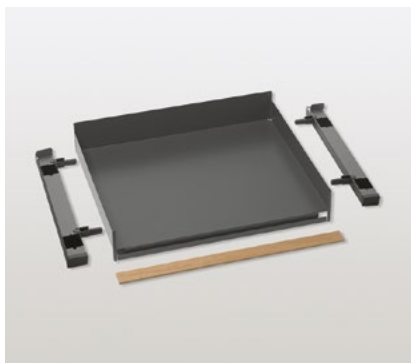

Extendo Fiore Universal pull-out shelf, low rail

Shelf for concealed extension runners, without spacer

- Suitable for use in open shelf units or as an internal pull-out behind front pull-outs, sliding doors or hinged doors with concealed hinges

Set includes:

- 1 Extendo Fiore shelf
- 1 wooden rail oak low (height 35 mm)
- 1 pair of universal adapters, compatible with drawer runners of Blum, Grass, Hettich, etc. with a nominal length of 450 mm

Load capacity: depends on the extension runner

Unit width	Surface	Width	Depth	Height	Art. No.
600	anthracite	550	495	116	200.1926.43
900	anthracite	850	495	116	200.1929.43

Other widths available on request



Extendo Fiore Universal pull-out shelf, high rail

Shelf for concealed extension runners, without spacer

- Suitable for use in open shelf units or as an internal pull-out behind front pull-outs, sliding doors or hinged doors with concealed hinges

Set includes:

- 1 Extendo Fiore shelf
- 1 wooden rail oak high (height 87 mm)
- 1 pair of universal adapters, compatible with drawer runners of Blum, Grass, Hettich, etc. with a nominal length of 450 mm

Load capacity: depends on the extension runner

Unit width	Surface	Width	Depth	Height	Art. No.
600	anthracite	550	495	116	200.1936.43
900	anthracite	850	495	116	200.1939.43

Other widths available on request

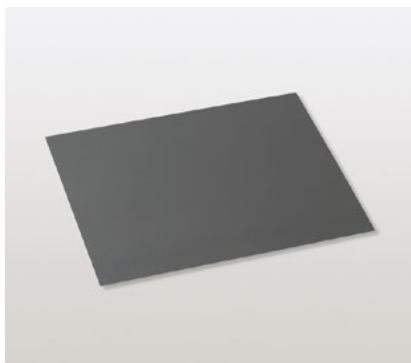

Non-slip mat Standard Fiore

For Extendo Fiore pull-out shelves without spacers

- Gummed surface
- Raised diamond pattern
- Easy to remove for cleaning

Unit width	Surface	Width	Depth	Height	Art. No.
600	grey	546	456	1	200.1966.18
900	grey	846	456	1	200.1969.18

Other widths available on request



Extra shelf set

For Extendo pull-out shelves without spacers

- Magnetic - the magnetic feet stick to Extendo pull-out shelves
- Shelf can be placed in three different positions
- An extra level of storage for pot lids and similar

Unit width	Surface	Width	Depth	Height	Art. No.
600	anthracite	534	226	160/164	200.1449.43
900	anthracite	834	226	160/164	200.1455.43



Rail

Magnetic clip-on shelf rail for Extendo pull-out shelf without spacers

- Optional divider system

Unit width	Surface	Width	Depth	Height	Art. No.
275	anthracite	182	7	42	200.1799.43
600	anthracite	532	7	42	200.1476.43
900	anthracite	832	7	42	200.1482.43

Other widths available on request

EXTENDO FIORO INCLUDING SPACER

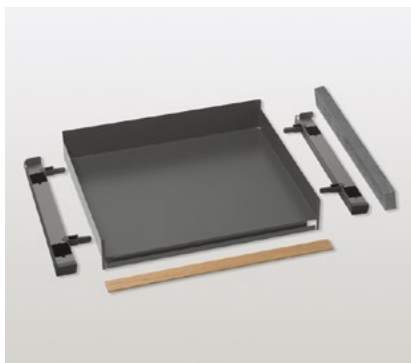

Extendo Fiore Universal pull-out shelf, low rail

Shelf for concealed extension runners, including spacer

- Suitable as an internal pull-out behind front pull-outs, for use with sliding doors or standard hinged doors

Set includes:

- 1 Extendo Fiore shelf
- 1 wooden rail oak low (height 35 mm)
- 1 pair of universal adapters, compatible with drawer runners of Blum, Grass, Hettich, etc. with a nominal length of 450 mm
- 1 spacer (900 mm sets include 2 spacers)

Unit width	Surface	Width	Depth	Height	Art. No.
450	anthracite	375	505	116	200.1843.43
600	anthracite	525	505	116	200.1846.43
900	anthracite	800	505	116	200.1849.43

Other widths available on request

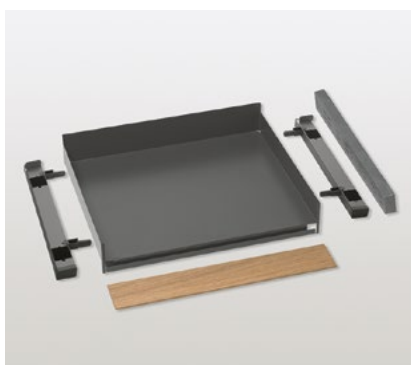

Extendo Fiore Universal pull-out shelf, high rail

Shelf for concealed extension runners, including spacer

- Suitable as an internal pull-out behind front pull-outs, for use with sliding doors or standard hinged doors

Set includes:

- 1 Extendo Fiore shelf
- 1 wooden rail oak high (height 87 mm)
- 1 pair of universal adapters, compatible with drawer runners of Blum, Grass, Hettich, etc. with a nominal length of 450 mm
- 1 spacer (900 mm sets include 2 spacers)

Unit width	Surface	Width	Depth	Height	Art. No.
450	anthracite	375	505	116	200.1853.43
600	anthracite	525	505	116	200.1856.43
900	anthracite	800	505	116	200.1859.43

Other widths available on request

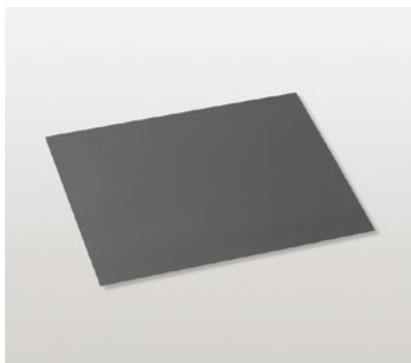

Non-slip mat Standard Fiore

For Extendo Fiore pull-out shelves with spacers

- Gummed surface
- Raised diamond pattern
- Easy to remove for cleaning

Unit width	Surface	Width	Depth	Height	Art. No.
450	grey	371	456	1	200.1891.18
600	grey	521	456	1	200.1894.18
900	grey	796	456	1	200.1897.18

Other widths available on request



Extra shelf set

For Extendo pull-out shelves with spacers

- Magnetic - the magnetic feet stick to Extendo pull-out shelves
- Shelf can be placed in three different positions
- An extra level of storage for pot lids and similar

Unit width	Surface	Width	Depth	Height	Art. No.
600	anthracite	510	226	160/164	200.1450.43
900	anthracite	785	226	160/164	200.1456.43



Rail

Magnetic clip-on shelf rail for Extendo pull-out shelf with spacers

- Optional divider system

Unit width	Surface	Width	Depth	Height	Art. No.
275	anthracite	182	7	42	200.1799.43
450	anthracite	357	7	42	200.1471.43
600	anthracite	507	7	42	200.1477.43
900	anthracite	782	7	42	200.1483.43

Other widths available on request

GENERAL ACCESSORIES FOR EXTENDO

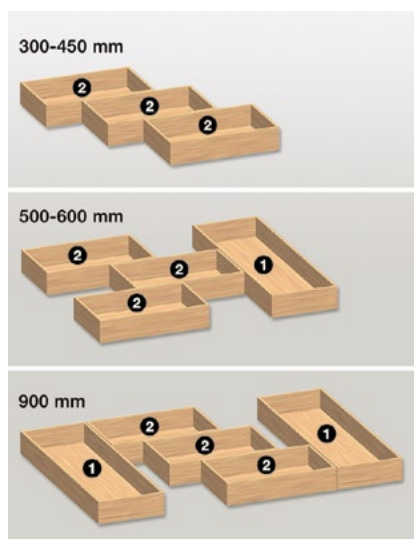

Wooden box sets “low” Extendo

For Extendo pull-out shelf

The sets contain combinations of following box types, as shown in the illustrations:

- #1 - long, low-sided box (446 x 150 x 50 mm)
- #2 - small, low-sided box (247 x 148 x 50 mm)

Including metal fasteners to connect the boxes

Unit width	Surface	Width	Depth	Height	Art. No.
300 - 450	Light oak				200.1677.36
500 - 600	Light oak				200.1675.36
900	Light oak				200.1673.36

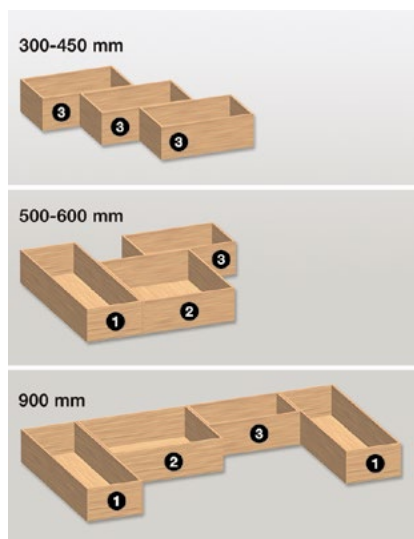

Wooden box sets “high” Extendo

For Extendo pull-out shelf

The sets contain combinations of following box types, as shown in the illustrations:

- #1 - long, high-sided box (446 x 150 x 87 mm)
- #2 - large, high-sided box (247 x 296 x 87 mm)
- #3 - small, high-sided box (247 x 148 x 87 mm)

Including metal fasteners to connect the boxes

Unit width	Surface	Width	Depth	Height	Art. No.
300 - 450	Light oak				200.1678.36
500 - 600	Light oak				200.1676.36
900	Light oak				200.1674.36



Shelf divider

Magnetic divider for Extendo pull-out shelf

- Can be attached to the shelf (base or side) or the non-slip mat

	Surface	Width	Depth	Height	Art. No.
	anthracite	85	26 / 3	90	100.0706.43

Order quantity: 4 pieces or a multiple per article number



Concealed extension runner Grass

Full-extension runner for Extendo pull-out shelf

- With liquid damping

Nominal length of the runner: 450 mm

Load capacity: 40 kg

Set of 1 pair

	Surface	Width	Depth	Height	Art. No.
	zinc plated	55	450	50	200.1408.04

Extendo pull-out shelf

Snello base unit pull-out



Snello base unit pull-out: The space-saving pull-out system for compact kitchens



Snello Fiore base unit pull-out

Base unit full-extension pull-out Comfort

- Includes 2 clip-on shelves Fiore
- Includes 4 wooden rails oak high (height 87 mm)
- Includes Softclose (top and bottom)

Load capacity type 150/200: 15 kg

Load capacity type 300: 20 kg

Unit width	Surface	Width	Depth	Height	Art. No.
150	anthracite	110	475	520	200.1864.43
200	anthracite	160	475	520	200.1865.43
300	anthracite	260	475	520	200.1866.43



Snello Fiore towel rail extension

Base unit full-extension pull-out Standard

- Includes 1 clip-on shelf Fiore
- Includes 2 wooden rails oak high (height 87 mm)
- Hand-towel rail with non-slip coating
- Includes a container for small utensils
- Includes Softclose (bottom)

Load capacity: 15 kg

Unit width	Surface	Width	Depth	Height	Art. No.
150	anthracite	110	475	660	200.1867.43



Non-slip mat Standard Fiore

For Snello Fiore base unit full-extension pull-out

- Gummed on both sides, raised diamond pattern
- Easy to remove for cleaning

Unit width	Surface	Width	Depth	Height	Art. No.
150	grey	83	431	1	200.1900.18
200	grey	133	431	1	200.1901.18
300	grey	233	431	1	200.1902.18



Shelf divider

Magnetic divider for Libell shelves

- Can be attached to the shelf (base or side) or the non-slip mat

	Surface	Width	Depth	Height	Art. No.
	anthracite	85	26 / 3	90	100.0706.43

Order quantity: 4 pieces or a multiple per article number

Magic Corner Comfort corner pull-out



Magic Corner Comfort corner pull-out: Optimal use of space in corner units



Picture: Mechanism left

Magic Corner Comfort

Complete mechanism set for hinged doors

Set includes:

- 1 back-wall frame
- 2 Softclose (side and back-wall frame)
- 1 pull-out frame with height-adjustable handle
- 1 swivel lever
- set of assembly material

Load capacity per clip-on component: Front: 10 kg / Back: 8 kg

Type	Surface	Width	Depth	Height	Art. No.
900 / left	anthracite	862-971	500	545	300.0581.43
900 / right	anthracite	862-971	500	545	300.0580.43
1000 / left	anthracite	962-1171	500	545	300.0583.43
1000 / right	anthracite	962-1171	500	545	300.0582.43



Clip-on shelf set Fioro

For Magic Corner Comfort type 900/1000

Set includes:

- 4 clip-on shelves Fioro
- 4 wooden rails oak medium (height 52 mm)
- Cross connectors and deflection clips

Door width min.	Surface	Width	Depth	Height	Art. No.
450	anthracite	290/280	470/470	90	300.0972.43
500	anthracite	290/330	470/470	90	300.0973.43
600	anthracite	390/380	470/470	90	300.0974.43

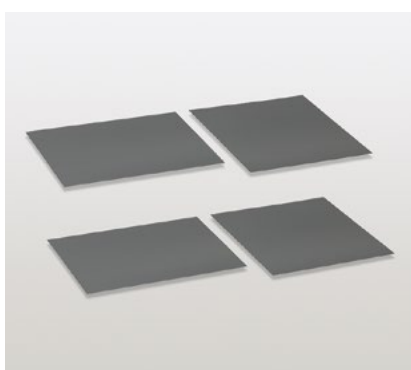

Non-slip mat set Standard Fioro

For the Fioro clip-on shelf set for Magic Corner Comfort

- Gummed surface, raised diamond pattern
- Easy to remove for cleaning

Door width min.	Surface	Width	Depth	Height	Art. No.
450	grey	283/270	456/466	1	300.0975.18
500	grey	283/320	456/466	1	300.0976.18
600	grey	383/370	456/466	1	300.0977.18



Shelf divider

Magnetic divider for Libell and Fioro shelves

- Can be attached to the shelf (base or side) or the non-slip mat

	Surface	Width	Depth	Height	Art. No.
	anthracite	85	26 / 3	90	100.0706.43

Order quantity: 4 pieces or a multiple per article number

Magic Corner Standard corner pull-out



Picture: Mechanism right

Magic Corner Standard corner pull-out: Just swing the front panel and the front shelves to one side and the back shelves automatically slide forwards.



Picture: Mechanism left

Magic Corner Standard

Complete mechanism set

Set includes:

- 1 back-wall frame
- 1 swivel frame
- 1 Softclose
- 1 front bracket
- 1 swivelling lever
- set of assembly material

Load capacity per clip-on component: Front: 7 kg / Back: 9 kg

Type	Surface	Width	Depth	Height	Art. No.
900 / left	anthracite	860-971	500	525	300.0826.43
900 / right	anthracite	862-971	500	525	300.0831.43

Other widths available on request

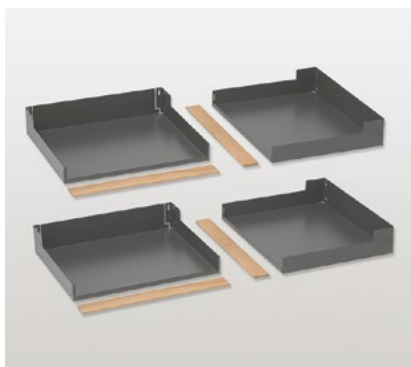

Clip-on shelf set Fioro

For Magic Corner Standard type 900

Set includes:

- 4 clip-on shelves Fioro
- 4 wooden rails oak medium (height 52 mm)

Door width min.	Surface	Width	Depth	Height	Art. No.
450	anthracite	470/280	380/470	90	300.0981.43

Other widths available on request

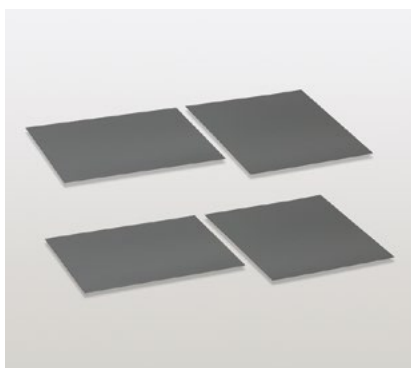

Non-slip mat set Standard Fioro

For the Fioro clip-on shelf set for Magic Corner Standard

- Gummed surface, raised diamond pattern
- Easy to remove for cleaning

Door width min.	Surface	Width	Depth	Height	Art. No.
450	grey	466/270	370/466	1	300.0984.18

Other widths available on request



Shelf divider

Magnetic divider for Libell and Fioro shelves

- Can be attached to the shelf (base or side) or the non-slip mat

	Surface	Width	Depth	Height	Art. No.
	anthracite	85	26 / 3	90	100.0706.43

Order quantity: 4 pieces or a multiple per article number

ISO 9001
BUREAU VERITAS
Certification



We remain committed to our high standards: We have developed and manufactured fittings and accessories for kitchens, bathrooms and living spaces at our site in Switzerland since 1964. Our 50 international patents ensure that the original products are always better than copies.

peka-system AG	T +41 41 919 94 20
Luzernerstrasse 20	F +41 41 919 94 29
6295 Mosen	peka@peka-system.ch
Switzerland	www.peka-system.ch



WWW.PEKA-SYSTEM.CH